



- Célula de carga de compresión de columna pivotante autocentrante
 - 4000 divisiones OIML R60 clase C
 - Disponible en versión **ATEX**  (opcional) Zona 0-1-2 (gas) y 20-21-22 (polvo)
 - Construcción en acero inoxidable
 - Herméticamente soldada, protección IP 68 (EN 60529) e IP 69K (ISO 20653)
 - Preajuste de esquinas optimizado para sistemas multicélulas
 - Protección antirrayos
 - Aplicaciones: Sistemas de pesaje de alta capacidad, especial para básculas puente pesacamiones
- Compression load cell, selfcentering column
 - 4000 divisions OIML R60 class C
 - Available in **ATEX**  version (optional) Zone 0-1-2 (gas) and 20-21-22 (dust)
 - Simple to install
 - Stainless Steel construction
 - Hermetically welded, protection class IP 68 (EN 60529) and IP 69K (ISO 20653)
 - Pre-corner adjustment optimized for multicell systems
 - Lightning protection
 - Applications: High capacity weighing systems, truck scales

Modelo Model	Carga nominal Nominal capacity Ln	Clase de precisión Accuracy class n. OIML	División mínima Minimum division vmin	Carga límite Safe load limit 150 % Ln	Carga rotura Breaking load > 350 % Ln
740 15 t	15 t	4000	1.5 kg	22.5 t	> 52.5 t
740 20 t	20 t	4000	2 kg	30 t	> 70 t
740 25 t	25 t	4000	2.5 kg	37.5 t	> 87.5 t
740 30 t	30 t	4000	3 kg	45 t	> 105 t
740 40 t	40 t	4000	4 kg	60 t	> 140 t
740 50 t	50 t	4000	5 kg	75 t	> 175 t
740 60 t	60 t	4000	6 kg	90 t	> 210 t



MODELO 740 + ACC. 74901 (15...50 t)
ACC. 74905 (60 t)

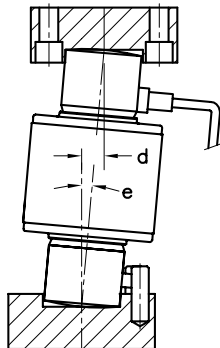
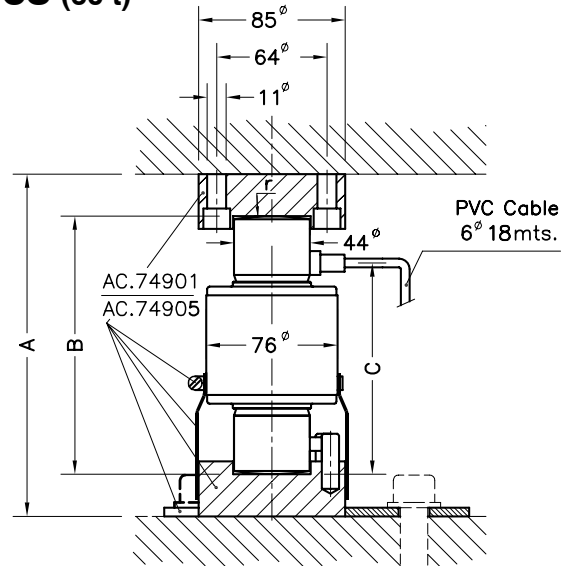
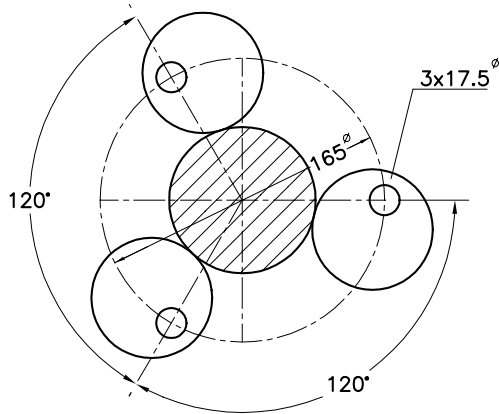

Células de carga Load cells	A	B	C	d max.	e max. perm. inclina.	r esf. Ball r	Peso Transport Weight
740 15 t	200	150	123	13	5°	130	2.5 kg
740 20 t	200	150	123	13	5°	130	2.5 kg
740 25 t	200	150	123	13	5°	150	2.6 kg
740 30 t	200	150	123	13	5°	160	2.6 kg
740 40 t	200	150	123	13	5°	180	2.8 kg
740 50 t	200	150	123	13	5°	180	2.9 kg
740 60 t	260	210	153	11	3°	220	3.8 kg
Acc. 74901	---	---	---	---	---	---	3 kg
Acc. 74905	---	---	---	---	---	---	3 kg

Dimensiones en mm. *Dimensions in mm.*

ESPECIFICACIONES			SPECIFICATIONS
Cargas nominales (Ln)	15-20-25-30-40-50-60	t	Nominal capacities (Ln)
Clase de precisión	4000	n. OIML	Accuracy class
Carga mínima	0	%Ln	Minimum dead load
Carga de servicio	120	%Ln	Service load
Cargas límite	150	%Ln	Safe load limit
Error combinado	< ±0.013	%Sn	Total error
Error repetibilidad	< ±0.01	%Sn	Repeatability error
Efecto de la temperatura: en el cero	< ±0.01	%Sn/5 °C	Temperature effect: on zero
en la sensibilidad	< ±0.006	%Sn/5 °C	on sensitivity
Error de fluencia (30 minutos)	< ±0.012	%Sn	Creep error (30 minutes)
Compensación de temperatura	-10...+40	°C	Temperature compensation
Límites de temperatura	-50...+80	°C	Temperature limits
Sensibilidad nominal (Sn)	2	mV/V (1)	Nominal sensitivity (Sn)
Tensión de alimentación nominal	10	V	Nominal input voltage
Tensión de alimentación máxima	15	V	Maximum input voltage
Resistencia de entrada	800 ±5	Ω	Input impedance
Resistencia de salida	705 ±5	Ω	Output impedance
Desequilibrio inicial	±2	%Sn	No load output
Resistencia de aislamiento	> 5000	MΩ	Insulation resistance
Deformación máxima (a Ln)	0.6-1	mm	Maximum deflection (at Ln)

CONEXIÓN ELÉCTRICA
ELECTRICAL CONNECTION:

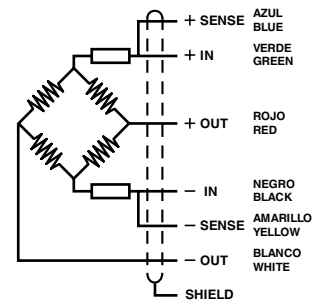

«SENSES»: 2 hilos adicionales, para mantener constante la alimentación en la célula, con una instrumentación adecuada. Utilizar especialmente para cables largos y amplio margen de temperatura.
 PANTALLA: No conectada al cuerpo del transductor.

«SENSES»: 2 additional wires to maintain a constant voltage supply at the load cell when used with proper instrumentation. Use specially when long wires and wide temperature range.
 SHIELD: Not connected to transducer body.

(1) Preajuste de esquinas optimizado al ±0.05% mediante la calibración de la corriente de salida /
 Pre-corner adjustment optimized at ±0.05% by output current calibration

ACCESORIOS PARA MODELO 740 (15...60t)
ACCESSORIES FOR MODEL 740 (15...60t)

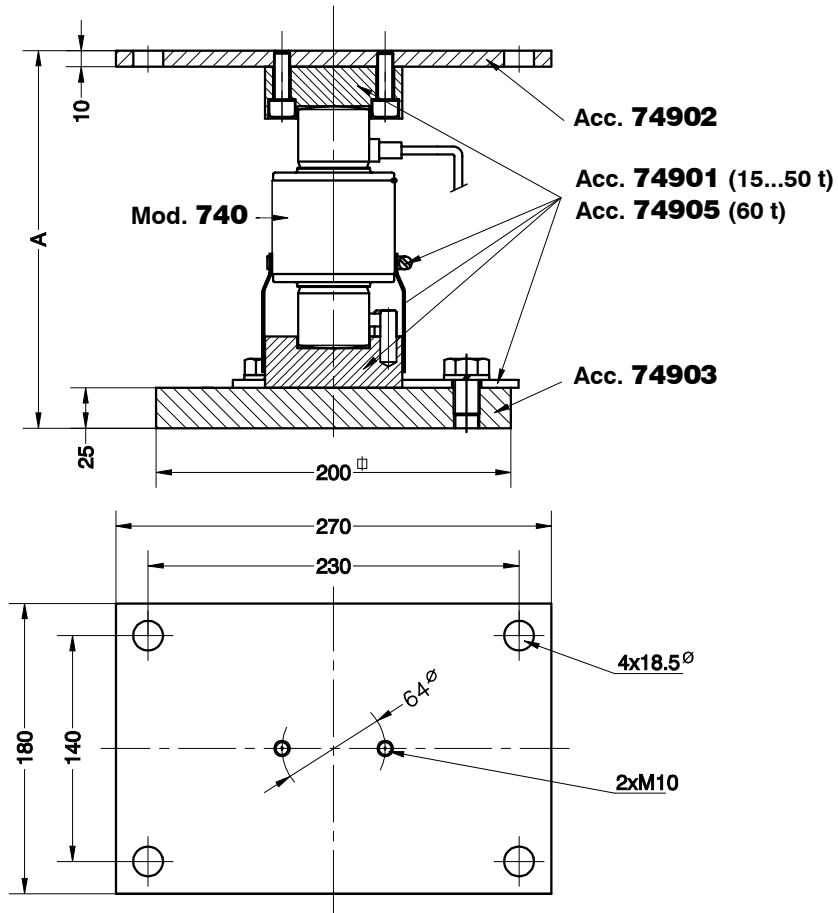

Accesorio Accessory	Modelo Model	A	Accesorio Accessory	Peso Transport Weight
74901 + 74902 + 74903	740 (15-20-25-30-40-50 t)	235	74901	3 kg
74905 + 74902 + 74903	740 (60 t)	295	74902	3.9 kg
			74903	9.7 kg
			74905	3 kg

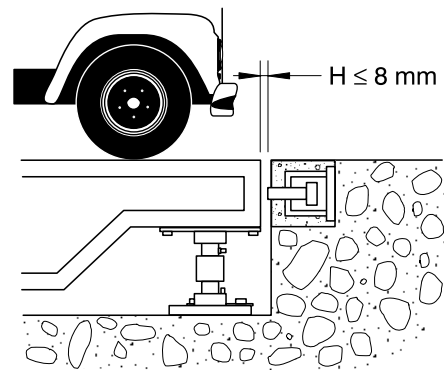
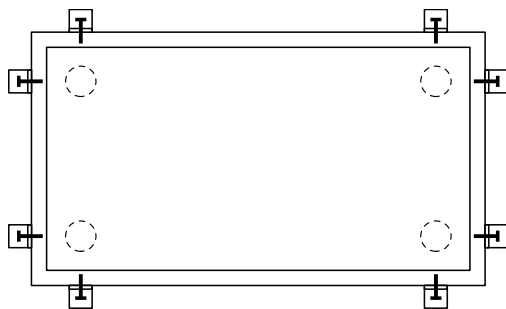

Dimensiones en mm. *Dimensions in mm.*

SOPORTE COMPLETO SILO CON ANTIVUELCO PARA M.740 (15...50t)
MOUNTING KIT LIFT-OFF PREVENTION FOR SILO FOR M.740 (15...50t)

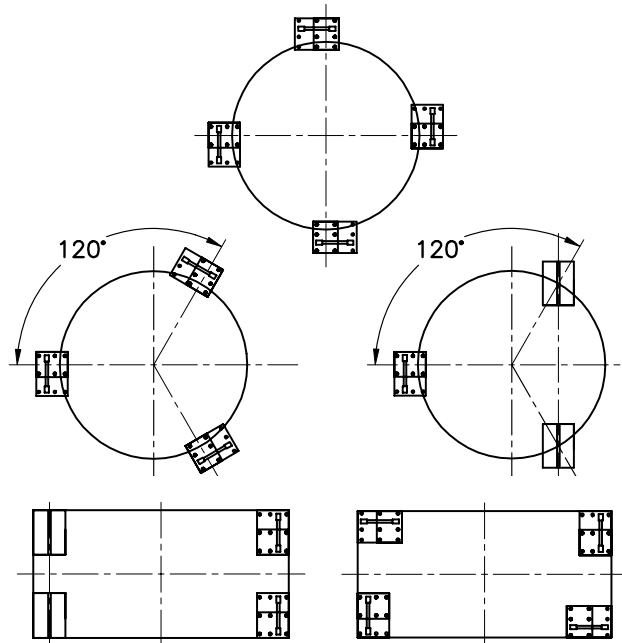
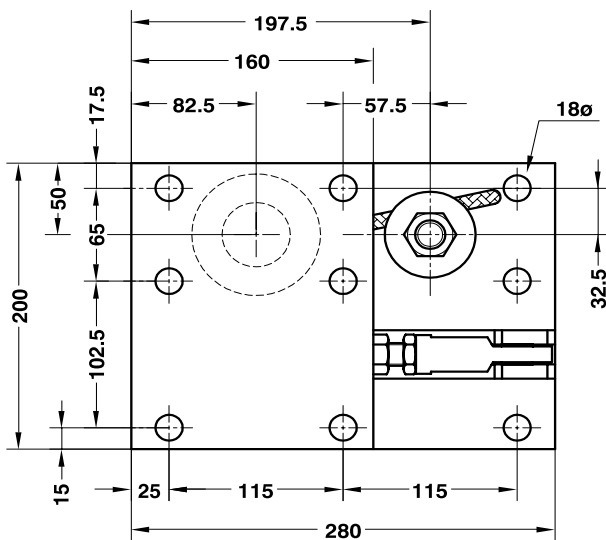
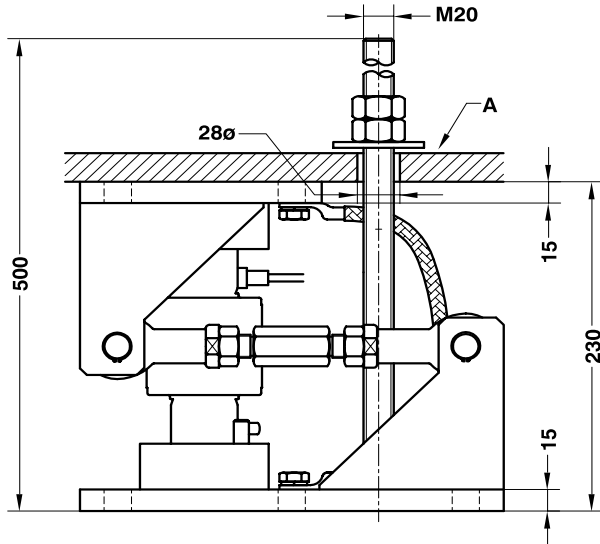

Capacidad	15...50 t	Nominal load
Máximo desplazamiento transversal al brazo de retención	±4 mm	Max. permissible side offset transverse to retention arm
Máxima fuerza admisible en la dirección del brazo retención	47 kN	Permissible horitz. force in direction of the retention arm
Máxima fuerza admisible de levantamiento	76 kN	Maximum permissible lifting force
Máximo desplazamiento vertical admisible (A)	3 mm	Max. permissible lifting movement, must be adjusted (A)
Material: Acero cincado		Material: Alloy Steel zinc-plated

Dimensiones en mm. Dimensions in mm.

Peso transporte Transport weight: 19 kg

SOPORTE COMPLETO SILO CON ANTIVUELCO M.740 (60t) MOUNTING KIT LIFT-OFF PREVENTION FOR SILO FOR M.740 (60t)

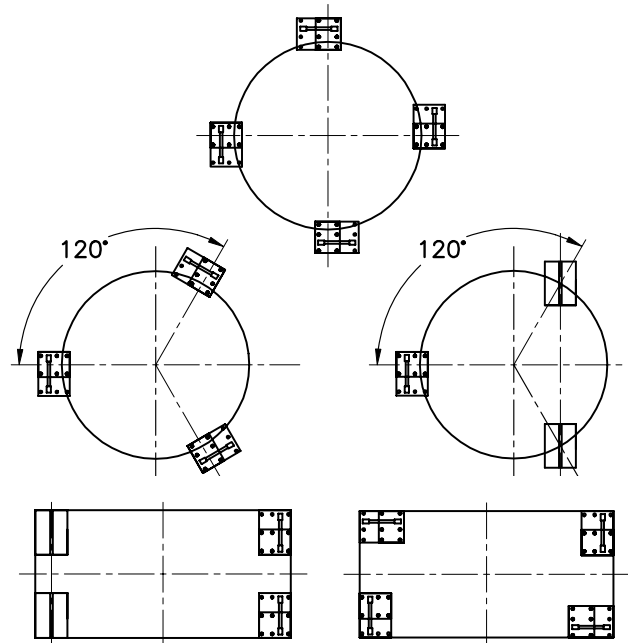
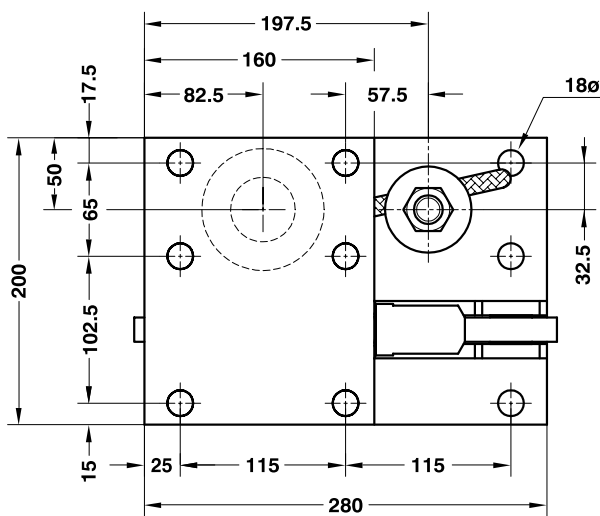
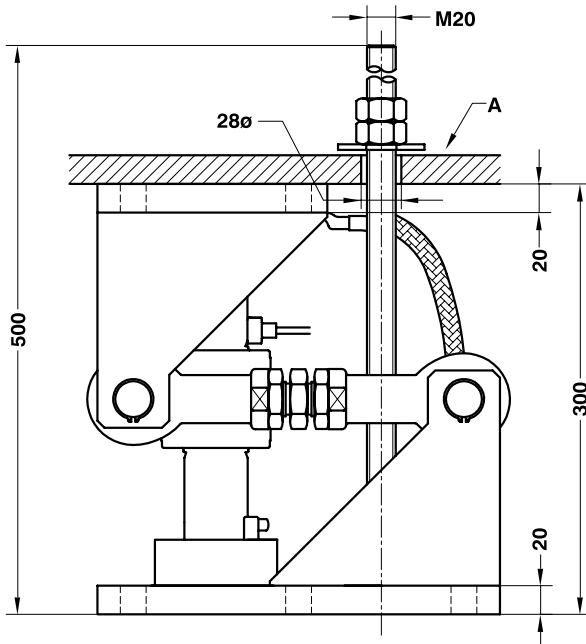

Capacidad	60 t	Nominal load
Máximo desplazamiento transversal al brazo de retención	±4 mm	Max. permissible side offset transverse to retention arm
Máxima fuerza admisible en la dirección del brazo retención	95 kN	Permissible horitz. force in direction of the retention arm
Máxima fuerza admisible de levantamiento	114 kN	Maximum permissible lifting force
Máximo desplazamiento vertical admisible (A)	3 mm	Max. permissible lifting movement, must be adjusted (A)
Material: Acero cincado		Material: Alloy Steel zinc-plated

Dimensiones en mm. Dimensions in mm.

Peso transporte Transport weight: 27 kg